

Sensitive SCRs

(0.8 A to 10 A) RoHS

General Description

The Teccor line of sensitive SCR semiconductors are half-wave unidirectional, gate-controlled rectifiers (SCR-thyristor) which complement Teccor's line of power SCRs. This group of packages offers ratings of 0.8 A to 10 A, and 200 V to 600 V with gate sensitivities of 12 μ A to 500 μ A. For gate currents in the 10 mA to 50 mA ranges, see "SCRs" section of this catalog.

The TO-220 and TO-92 are electrically isolated where the case or tab is internally isolated to allow the use of low-cost assembly and convenient packaging techniques.

Teccor's line of SCRs features glass-passivated junctions to ensure long-term device reliability and parameter stability. Teccor's glass offers a rugged, reliable barrier against junction contamination.

Tape-and-reel packaging is available for the TO-92 package. Consult the factory for more information.





Variations of devices covered in this data sheet are available for custom design applications. Consult the factory for more information.

Features

- RoHS Compliant
- Electrically-isolated TO-220 package
- High voltage capability — up to 600 V
- High surge capability — up to 100 A
- Glass-passivated chip

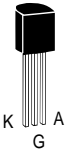
Compak Features

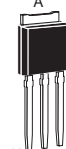
- Surface mount package — 0.8 A series
- New small-profile three-leaded Compak package
- Four gate sensitivities available
- Packaged in embossed carrier tape with 2,500 devices per reel
- Can replace SOT-223

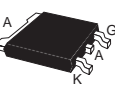
TYPE	Part Number					I_T		V_{DRM} & V_{RRM}	I_{GT}	I_{DRM} & I_{RRM}			V_{TM}	
	Non-isolated					I_T				I_{DRM} & I_{RRM}				
						Amps		Volts	μ Amps	μ Amps				
	TO-92	TO-202	TO-251 V-Pak	Compak	TO-252 D-Pak	$I_{T(RMS)}$	$I_{T(AV)}$			T_C or $T_L = 25^\circ C$	T_C or $T_L = 100^\circ C$	T_C or $T_L = 110^\circ C$		
See "Package Dimensions" section for variations. (11)					MAX	MAX	MIN	MAX	MAX	MAX	MAX			
0.8 A				S2S1		0.8	0.51	200	12	2		100	1.7	
				S4S1		0.8	0.51	400	12	2		100	1.7	
				S6S1		0.8	0.51	600	12	2		100	1.7	
				S2S2		0.8	0.51	200	50	2		100	1.7	
				S4S2		0.8	0.51	400	50	2		100	1.7	
				S6S2		0.8	0.51	600	50	2		100	1.7	
				S2S		0.8	0.51	200	200	2		100	1.7	
				S4S		0.8	0.51	400	200	2		100	1.7	
				S6S		0.8	0.51	600	200	2		100	1.7	
				S2S3		0.8	0.51	200	500	2		100	1.7	
				S4S3		0.8	0.51	400	500	2		100	1.7	
				S6S3		0.8	0.51	600	500	2		100	1.7	
		EC103B				0.8	0.51	200	200	1	50		100	1.7
		EC103D				0.8	0.51	400	200	1	50		100	1.7
		EC103M				0.8	0.51	600	200	2	100		100	1.7
		EC103B1				0.8	0.51	200	12	1	50		100	1.7
		EC103D1				0.8	0.51	400	12	1	50		100	1.7
		EC103M1				0.8	0.51	600	12	2	100		100	1.7
		EC103B2				0.8	0.51	200	50	1	50		100	1.7
		EC103D2				0.8	0.51	400	50	1	50		100	1.7
	EC103M2				0.8	0.51	600	50	2	100		100	1.7	
	EC103B3				0.8	0.51	200	500	1	50		100	1.7	
	EC103D3				0.8	0.51	400	500	1	50		100	1.7	
	EC103M3				0.8	0.51	600	500	2	100		100	1.7	
	2N5064				0.8	0.51	200	200	1		50	100	1.7	
	2N6565				0.8	0.51	400	200	1		100	100	1.7	
1.5 A						1.5	0.95	200	200	1		100	1.5	
						1.5	0.95	400	200	1		100	1.5	
						1.5	0.95	600	200	2		100	1.5	
4 A		T106B1				4	2.5	200	200	2		100	2.2	
		T106D1				4	2.5	400	200	2		100	2.2	
		T106M1				4	2.5	600	200	2		100	2.2	
		T107B1				4	2.5	200	500	2		100	2.5	
		T107D1				4	2.5	400	500	2		100	2.5	
		T107M1				4	2.5	600	500	2		100	2.5	
			S2004VS1		S2004DS1	4	2.5	200	50	2		100	1.6	
			S4004VS1		S4004DS1	4	2.5	400	50	2		100	1.6	
			S6004VS1		S6004DS1	4	2.5	600	50	2		100	1.6	
			S2004VS2		S2004DS2	4	2.5	200	200	2		100	1.6	
		S4004VS2		S4004DS2	4	2.5	400	200	2		100	1.6		
		S6004VS2		S6004DS2	4	2.5	600	200	2		100	1.6		

See "General Notes" on page E5 - 4 and "Electrical Specifications Notes" on page E5 - 5

V _{GT}			I _H	I _{GM}	V _{GRM}	P _{GM}	P _{G(AV)}	I _{TSM}	dv/dt		di/dt	t _{gt}	t _q	I ² t
(4) (12) (22)			(5) (15) (16) (19)	(17)		(17)		(6) (7) (13)				(8)	(9)	
Volts								Amps						
T _C or T _L = -40 °C	T _C or T _L = 25 °C	T _C or T _L = 110 °C	mAmps	Amps	Volts	Watts	Watts	60/50 Hz		Volts/μSec	Amps/μSec	μSec	μSec	Amps ² /Sec
MAX			MAX		MIN				MIN	TYP (23)		TYP	MAX	
1.2	0.8	0.2	5	1	5	1	0.1	20/16	20		50	2	60	1.6
1.2	0.8	0.2	5	1	5	1	0.1	20/16	20		50	2	60	1.6
1.2	0.8	0.2	5	1	5	1	0.1	20/16	10		50	2	60	1.6
1.2	0.8	0.25	5	1	5	1	0.1	20/16	25		50	3	60	1.6
1.2	0.8	0.25	5	1	5	1	0.1	20/16	25		50	3	60	1.6
1.2	0.8	0.25	5	1	5	1	0.1	20/16	10		50	3	60	1.6
1.2	0.8	0.25	5	1	5	1	0.1	20/16	30		50	4	50	1.6
1.2	0.8	0.25	5	1	5	1	0.1	20/16	30		50	4	50	1.6
1.2	0.8	0.25	5	1	5	1	0.1	20/16	15		50	4	50	1.6
1.2	0.8	0.25	8	1	5	1	0.1	20/16	40		50	5	45	1.6
1.2	0.8	0.25	8	1	5	1	0.1	20/16	40		50	5	45	1.6
1.2	0.8	0.25	8	1	5	1	0.1	20/16	20		50	5	45	1.6
1.2	0.8	0.25	5	1	5	1	0.1	20/16	30		50	3.5	50	1.6
1.2	0.8	0.25	5	1	5	1	0.1	20/16	30		50	3.5	50	1.6
1.2	0.8	0.25	5	1	5	1	0.1	20/16	15		50	3.5	50	1.6
1.2	0.8	0.2	5	1	5	1	0.1	20/16	20		50	2	60	1.6
1.2	0.8	0.2	5	1	5	1	0.1	20/16	20		50	2	60	1.6
1.2	0.8	0.2	5	1	5	1	0.1	20/16	10		50	2	60	1.6
1.2	0.8	0.25	5	1	5	1	0.1	20/16	25		50	3	60	1.6
1.2	0.8	0.25	5	1	5	1	0.1	20/16	25		50	3	60	1.6
1.2	0.8	0.25	5	1	5	1	0.1	20/16	10		50	3	60	1.6
1.2	0.8	0.25	8	1	5	1	0.1	20/16	40		50	5	45	1.6
1.2	0.8	0.25	8	1	5	1	0.1	20/16	40		50	5	45	1.6
1.2	0.8	0.25	8	1	5	1	0.1	20/16	20		50	5	45	1.6
1.2	0.8	0.25	5	1	5	1	0.1	20/16	25		50	2.2	60	1.6
1.2	0.8	0.25	5	1	6	1	0.1	20/16	25		50	2.2	60	1.6
1	0.8	0.25	5	1	6	1	0.1	20/16	60		50	3.5	50	1.6
1	0.8	0.25	5	1	6	1	0.1	20/16	40		50	3.5	50	1.6
1	0.8	0.25	5	1	6	1	0.1	20/16	30		50	3.5	50	1.6
1	0.8	0.2	5	1	6	1	0.1	20/16		8	50	4	50	1.6
1	0.8	0.2	5	1	6	1	0.1	20/16		8	50	4	50	1.6
1	0.8	0.2	5	1	6	1	0.1	20/16		8	50	4	50	1.6
1	0.8	0.2	6	1	6	1	0.1	20/16		8	50	5	45	1.6
1	0.8	0.2	6	1	6	1	0.1	20/16		8	50	5	45	1.6
1	0.8	0.2	6	1	6	1	0.1	20/16		8	50	5	45	1.6
1	0.8	0.2	4	1	6	1	0.1	30/25		8	50	3	50	3.7
1	0.8	0.2	4	1	6	1	0.1	30/25		8	50	3	50	3.7
1	0.8	0.2	4	1	6	1	0.1	30/25		8	50	3	50	3.7
1	0.8	0.2	6	1	6	1	0.1	30/25		8	50	4	50	3.7
1	0.8	0.2	6	1	6	1	0.1	30/25		8	50	4	50	3.7
1	0.8	0.2	6	1	6	1	0.1	30/25		8	50	4	50	3.7

See "General Notes" on page E5 - 4 and "Electrical Specifications Notes" on page E5 - 5

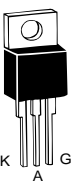
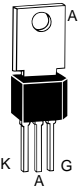
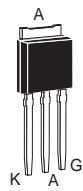
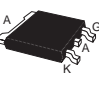
TYPE	Part Number				I _T		V _{DRM} & V _{R_{RRM}}	I _{GT}	I _{DRM} & I _{R_{RRM}}		V _{TM}
	Isolated	Non-isolated									
					(1)			(2) (12)	(20) (21)		(3) (10)
	TO-220	TO-202	TO-251 V-Pak	TO-252 D-Pak	Amps				μAmps		
See "Package Dimensions" section for variations. (11)				I _{T(RMS)}	I _{T(AV)}	Volts	μAmps	T _C = 25 °C	T _C = 110 °C	Volts	
				MAX	MAX	MIN	MAX	MAX	MAX	MAX	
6 A	S2006LS2	S2006FS21	S2006VS2	S2006DS2	6	3.8	200	200	5	250	1.6
	S4006LS2	S4006FS21	S4006VS2	S4006DS2	6	3.8	400	200	5	250	1.6
	S6006LS2	S6006FS21	S6006VS2	S6006DS2	6	3.8	600	200	5	250	1.6
	S2006LS3	S2006FS31	S2006VS3	S2006DS3	6	3.8	200	500	5	250	1.6
	S4006LS3	S4006FS31	S4006VS3	S4006DS3	6	3.8	400	500	5	250	1.6
	S6006LS3	S6006FS31	S6006VS3	S6006DS3	6	3.8	600	500	5	250	1.6
8 A	S2008LS2	S2008FS21	S2008VS2	S2008DS2	8	5.1	200	200	5	250	1.6
	S4008LS2	S4008FS21	S4008VS2	S4008DS2	8	5.1	400	200	5	250	1.6
	S6008LS2	S6008FS21	S6008VS2	S6008DS2	8	5.1	600	200	5	250	1.6
	S2008LS3	S2008FS31	S2008VS3	S2008DS3	8	5.1	200	500	5	250	1.6
	S4008LS3	S4008FS31	S4008VS3	S4008DS3	8	5.1	400	500	5	250	1.6
	S6008LS3	S6008FS31	S6008VS3	S6008DS3	8	5.1	600	500	5	250	1.6
10 A	S2010LS2	S2010FS21	S2010VS2	S2010DS2	10	6.4	200	200	5	250	1.6
	S4010LS2	S4010FS21	S4010VS2	S4010DS2	10	6.4	400	200	5	250	1.6
	S6010LS2	S6010FS21	S6010VS2	S6010DS2	10	6.4	600	200	5	250	1.6
	S2010LS3	S2010FS31	S2010VS3	S2010DS3	10	6.4	200	500	5	250	1.6
	S4010LS3	S4010FS31	S4010VS3	S4010DS3	10	6.4	400	500	5	250	1.6
	S6010LS3	S6010FS31	S6010VS3	S6010DS3	10	6.4	600	500	5	250	1.6

Specific Test Conditions

- di/dt** — Maximum rate-of-change of on-state current; I_{GT} = 50 mA pulse width ≥15 μsec with ≤0.1 μs rise time
- dv/dt** — Critical rate-of-rise of forward off-state voltage
- I²t** — RMS surge (non-repetitive) on-state current for period of 8.3 ms for fusing
- I_{DRM} and I_{R_{RRM}}** — Peak off-state current at V_{DRM} and V_{R_{RRM}}
- I_{GT}** — DC gate trigger current V_D = 6 V dc; R_L = 100 Ω
- I_{GM}** — Peak gate current
- I_H** — DC holding current; initial on-state current = 20 mA
- I_T** — Maximum on-state current
- I_{TSM}** — Peak one-cycle forward surge current
- P_{G(AV)}** — Average gate power dissipation
- P_{GM}** — Peak gate power dissipation
- t_{gt}** — Gate controlled turn-on time gate pulse = 10 mA; minimum width = 15 μS with rise time ≤0.1 μs
- t_q** — Circuit commutated turn-off time
- V_{DRM} and V_{R_{RRM}}** — Repetitive peak off-state forward and reverse voltage
- V_{GRM}** — Peak reverse gate voltage
- V_{GT}** — DC gate trigger voltage; V_D = 6 V dc; R_L = 100 Ω
- V_{TM}** — Peak on-state voltage





General Notes

- Teccor 2N5064 and 2N6565 Series devices conform to all JEDEC registered data. See specifications table on pages E5 - 2 and E5 - 3.
- The case lead temperature (T_C or T_L) is measured as shown on dimensional outline drawings in the "Package Dimensions" section of this catalog.
- All measurements (except I_{GT}) are made with an external resistor R_{GK} = 1 kΩ unless otherwise noted.
- All measurements are made at 60 Hz with a resistive load at an ambient temperature of +25 °C unless otherwise specified.
- Operating temperature (T_J) is -65 °C to +110 °C for EC Series devices, -65 °C to +125 °C for 2N Series devices, -40 °C to +125 °C for "TCR" Series, and -40 °C to +110 °C for all others.
- Storage temperature range (T_S) is -65 °C to +150 °C for TO-92 devices, -40 °C to +150 °C for TO-202 and Compak devices, and -40 °C to +125 °C for all others.
- Lead solder temperature is a maximum of +230 °C for 10 seconds maximum ≥1/16" (1.59 mm) from case.

V _{GT}			I _H	I _{GM}	V _{GRM}	P _{GM}	P _{G(AV)}	I _{TSM}	dv/dt	di/dt	t _{gt}	t _q	I ² t
(4) (12) (22)			(5) (19)	(17)		(17)		(6) (13)			(8)	(9)	
Volts									Volts/μSec				
T _C = -40 °C	T _C = 25 °C	T _C = 110 °C	mAmps	Amps	Volts	Watts	Watts	Amps	T _C = 110 °C	Amps/μSec	μSec	μSec	Amps ² Sec
MAX			MAX		MIN			60/50 Hz	TYP		TYP	MAX	
1	0.8	0.25	6	1	6	1	0.1	100/83	10	100	4	50	41
1	0.8	0.25	6	1	6	1	0.1	100/83	8	100	4	50	41
1	0.8	0.25	6	1	6	1	0.1	100/83	8	100	4	50	41
1	0.8	0.25	8	1	6	1	0.1	100/83	10	100	5	45	41
1	0.8	0.25	8	1	6	1	0.1	100/83	8	100	5	45	41
1	0.8	0.25	8	1	6	1	0.1	100/83	8	100	5	45	41
1	0.8	0.25	6	1	6	1	0.1	100/83	10	100	4	50	41
1	0.8	0.25	6	1	6	1	0.1	100/83	8	100	4	50	41
1	0.8	0.25	6	1	6	1	0.1	100/83	8	100	4	50	41
1	0.8	0.25	8	1	6	1	0.1	100/83	10	100	5	45	41
1	0.8	0.25	8	1	6	1	0.1	100/83	8	100	5	45	41
1	0.8	0.25	8	1	6	1	0.1	100/83	8	100	5	45	41
1	0.8	0.25	6	1	6	1	0.1	100/83	10	100	4	50	41
1	0.8	0.25	6	1	6	1	0.1	100/83	8	100	4	50	41
1	0.8	0.25	6	1	6	1	0.1	100/83	8	100	4	50	41
1	0.8	0.25	8	1	6	1	0.1	100/83	10	100	5	45	41
1	0.8	0.25	8	1	6	1	0.1	100/83	8	100	5	45	41
1	0.8	0.25	8	1	6	1	0.1	100/83	8	100	5	45	41

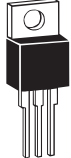
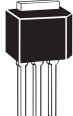
Electrical Specifications Notes

- (1) See Figure E5.1 through Figure E5.9 for current ratings at specified operating temperatures.
- (2) See Figure E5.10 for I_{GT} versus T_C or T_L.
- (3) See Figure E5.11 for instantaneous on-state current (I_T) versus on-state voltage (V_T) TYP.
- (4) See Figure E5.12 for V_{GT} versus T_C or T_L.
- (5) See Figure E5.13 for I_H versus T_C or T_L.
- (6) For more than one full cycle, see Figure E5.14.
- (7) 0.8 A to 4 A devices also have a pulse peak forward current on-state rating (repetitive) of 75 A. This rating applies for operation at 60 Hz, 75 °C maximum tab (or anode) lead temperature, switching from 80 V peak, sinusoidal current pulse width of 10 μs minimum, 15 μs maximum. See Figure E5.20 and Figure E5.21.
- (8) See Figure E5.15 for t_{gt} versus I_{GT}.
- (9) Test conditions as follows:
 - T_C or T_L ≤ 80 °C, rectangular current waveform
 - Rate-of-rise of current ≤ 10 A/μs
 - Rate-of-reversal of current ≤ 5 A/μs
 - I_{TM} = 1 A (50 μs pulse), Repetition Rate = 60 pps
 - V_{RRM} = Rated
 - V_R = 15 V minimum, V_{DRM} = Rated
 - Rate-of-rise reapplied forward blocking voltage = 5 V/μs
 - Gate Bias = 0 V, 100 Ω (during turn-off time interval)
- (10) Test condition is maximum rated RMS current except TO-92 devices are 1.2 A_{PK}; T106/T107 devices are 4 A_{PK}.
- (11) See package outlines for lead form configurations. When ordering special lead forming, add type number as suffix to part number.
- (12) V_D = 6 V dc, R_L = 100 Ω (See Figure E5.19 for simple test circuit for measuring gate trigger voltage and gate trigger current.)
- (13) See Figure E5.1 through Figure E5.9 for maximum allowable case temperature at maximum rated current.
- (14) I_{GT} = 500 μA maximum at T_C = -40 °C for T106 devices
- (15) I_H = 10 mA maximum at T_C = -65 °C for 2N5064 Series and 2N6565 Series devices
- (16) I_H = 6 mA maximum at T_C = -40 °C for T106 devices
- (17) Pulse Width ≤ 10 μs
- (18) I_{GT} = 350 μA maximum at T_C = -65 °C for 2N5064 Series and 2N6565 Series devices
- (19) Latching current can be higher than 20 mA for higher I_{GT} types. Also, latching current can be much higher at -40 °C. See Figure E5.18.
- (20) T_C or T_L = T_J for test conditions in off state
- (21) I_{DRM} and I_{RRM} = 50 μA for 2N5064 and 100 μA for 2N6565 at 125 °C
- (22) TO-92 devices specified at -65 °C instead of -40 °C
- (23) T_C = 110 °C

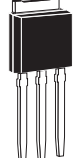
Thermal Resistance (Steady State) $R_{\theta JC}$ [$R_{\theta JA}$] °C/W (TYPICAL)							
Package Code	E	L	F2	F	C	D	V
Type	 TO-92	 TO-220	 TO-202 Type 2, 4, & 41	 TO-202 Type 1 & 3	 Compak	 TO-252 D-Pak	 TO-251 V-Pak
0.8 A	75 [160]				60*		
1.5 A	50 [160]						
4.0 A			10 [100]	6.2 [80]		3.0	3.8 [85]
6.0 A		4.0 [65]		4.3		1.8	2.4
8.0 A		3.4		3.9		1.5	2.1
10.0 A		3.0		3.4		1.45	1.72

*Mounted on 1 cm² copper foil surface; two-ounce copper foil

Electrical Isolation

Tecor's isolated sensitive SCRs will withstand a minimum high potential test of 2500 V ac rms from leads to mounting tab over the device's operating temperature range. The following table shows other standard and optional isolation ratings.

Electrical Isolation * from Leads to Mounting Tab	
V AC RMS	TO-220
2500	Standard
4000	Optional **

*UL Recognized File #E71639

**For 4000 V isolation, use "V" suffix in part number.

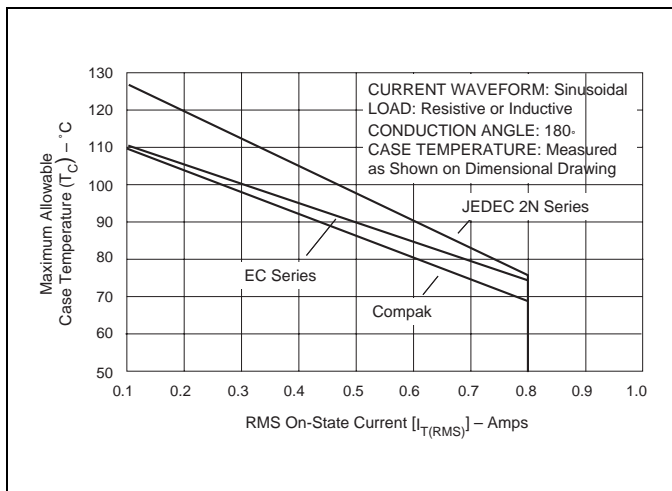

Figure E5.1 Maximum Allowable Case Temperature versus RMS On-state Current

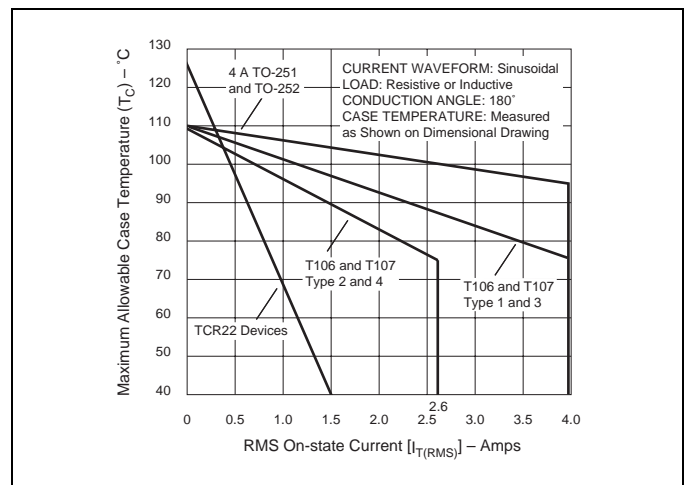

Figure E5.2 Maximum Allowable Case Temperature versus RMS On-state Current

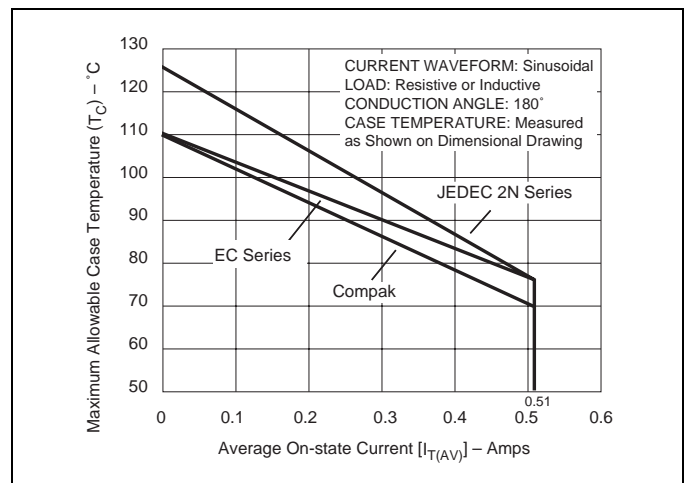

Figure E5.3 Maximum Allowable Case Temperature versus Average On-state Current

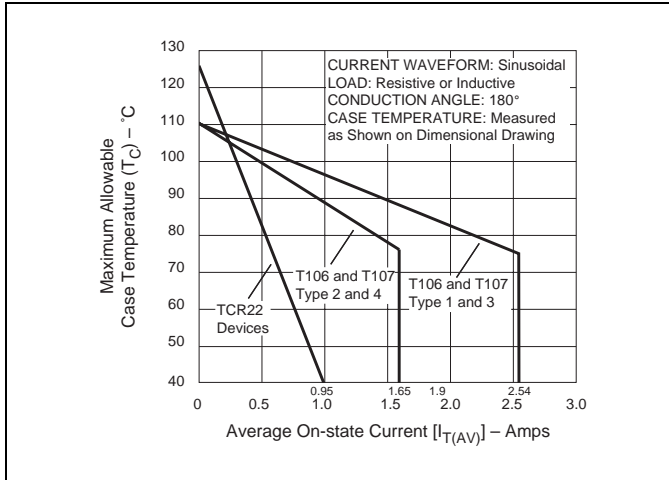

Figure E5.4 Maximum Allowable Case Temperature versus Average On-state Current

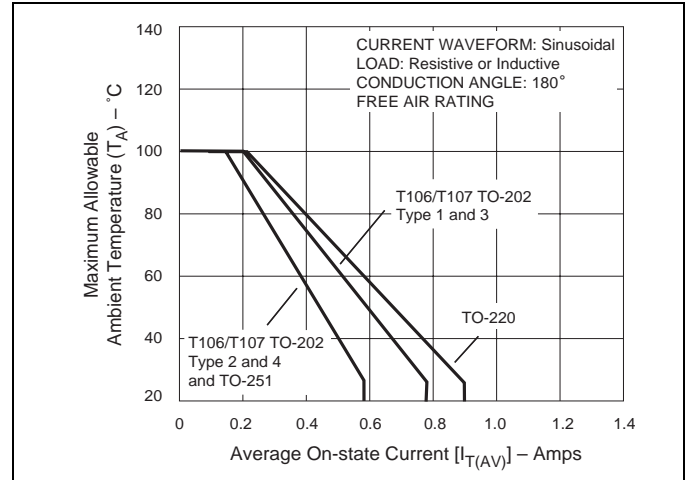

Figure E5.7 Maximum Allowable Ambient Temperature versus Average On-state Current

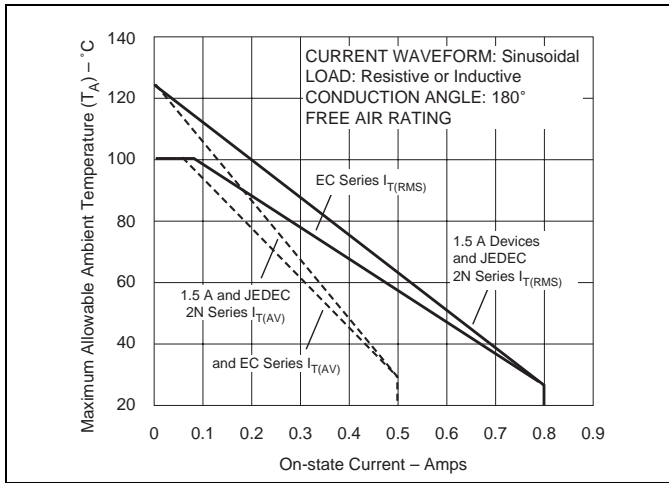

Figure E5.5 Maximum Allowable Ambient Temperature versus On-state Current

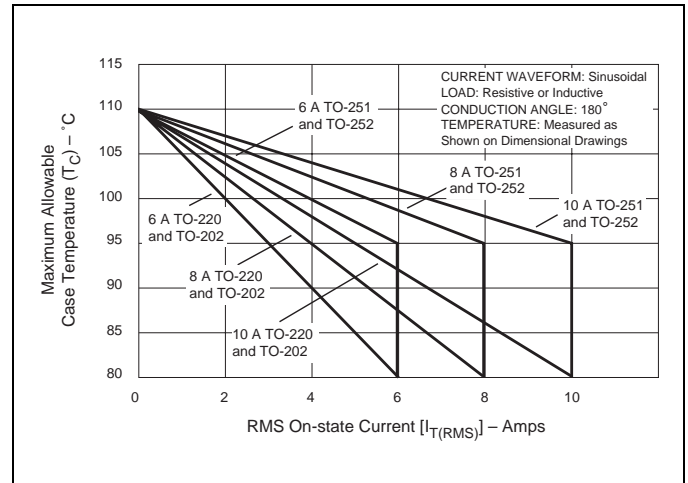

Figure E5.8 Maximum Allowable Case Temperature versus RMS On-state Current

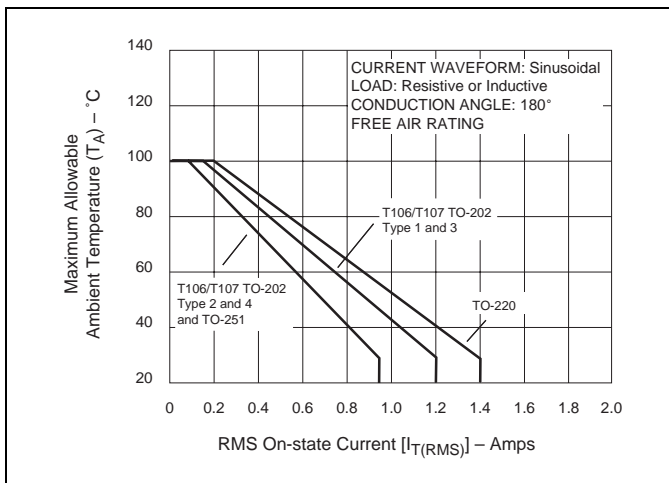

Figure E5.6 Maximum Allowable Ambient Temperature versus RMS On-state Current

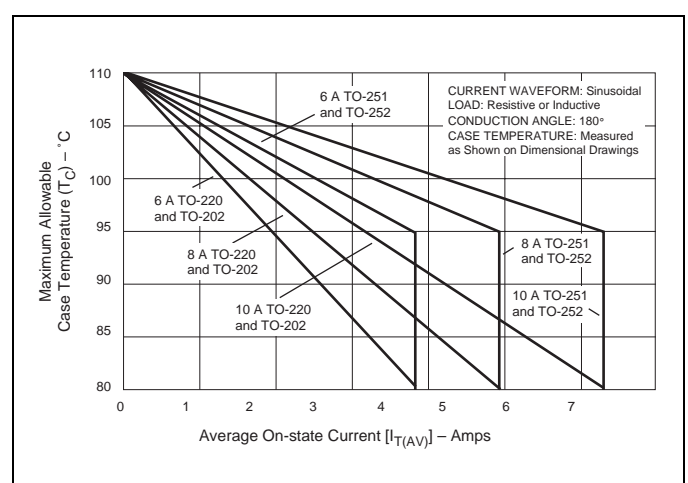

Figure E5.9 Maximum Allowable Case Temperature versus Average On-state Current

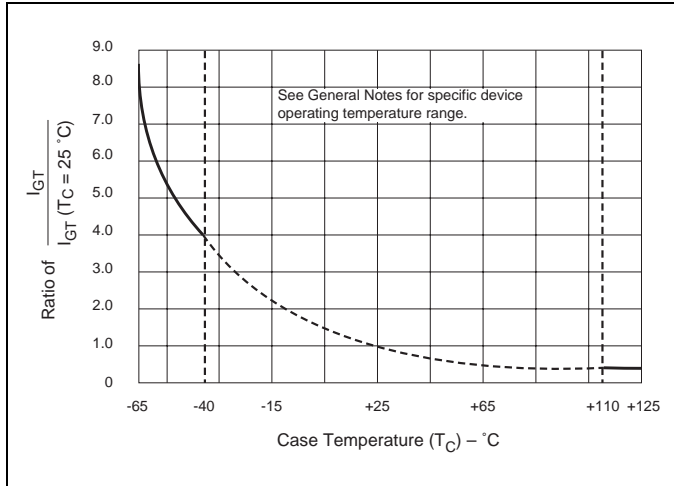

Figure E5.10 Normalized DC Gate-Trigger Current versus Case Temperature

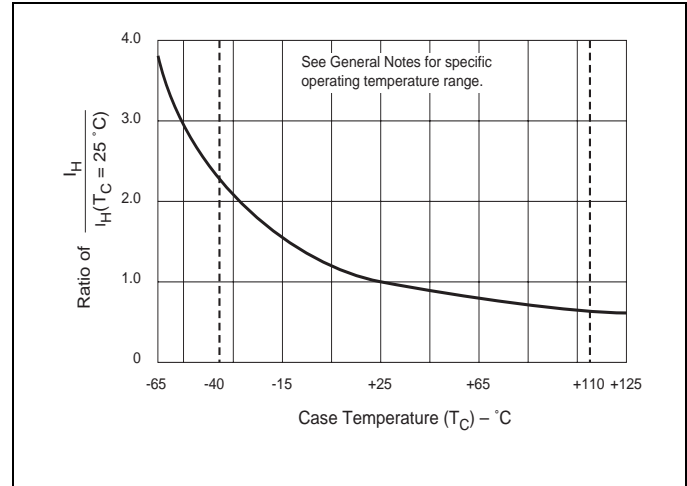

Figure E5.13 Normalized DC Holding Current versus Case Temperature

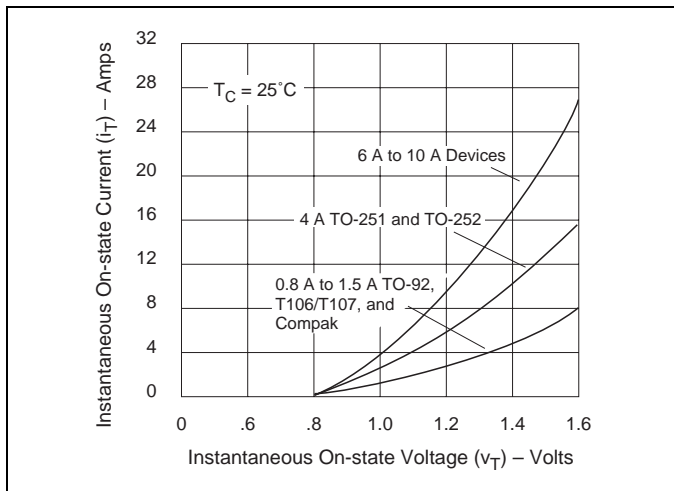

Figure E5.11 Instantaneous On-state Current versus On-state Voltage (Typical)

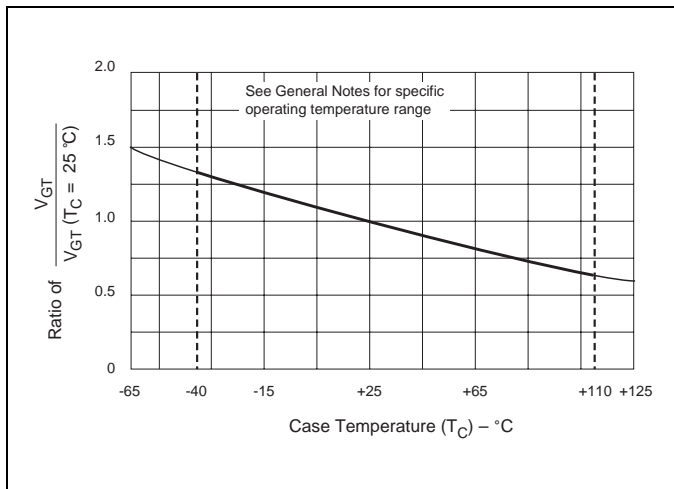

Figure E5.12 Normalized DC Gate-Trigger Voltage versus Case Temperature

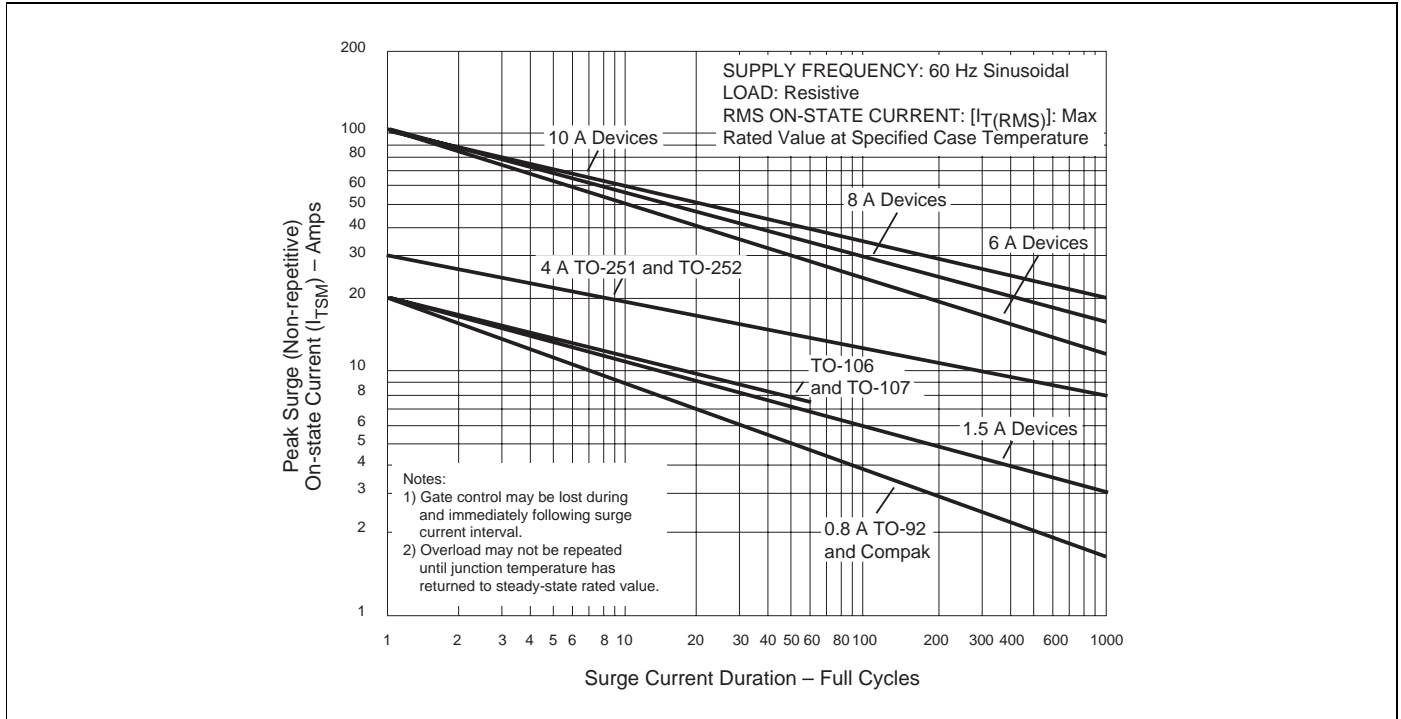

Figure E5.14 Peak Surge On-state Current versus Surge Current Duration

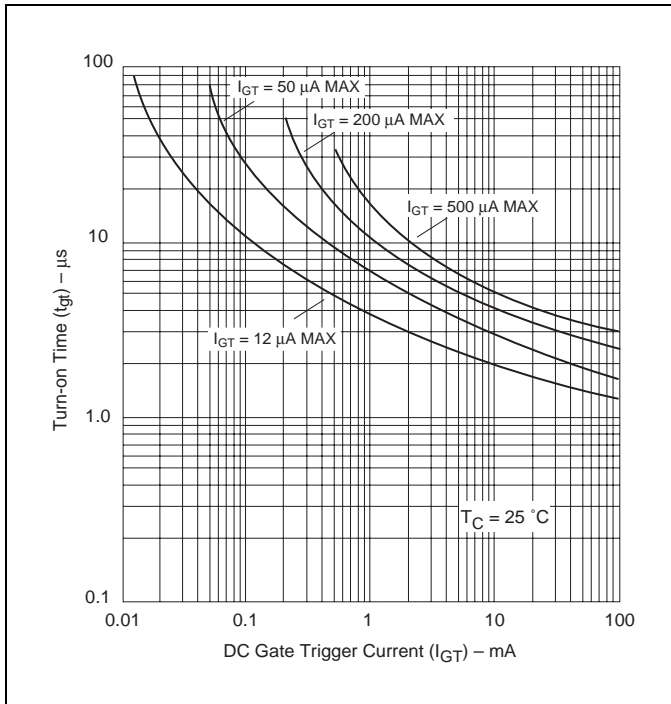

Figure E5.15 Typical Turn-on Time versus Gate Trigger Current

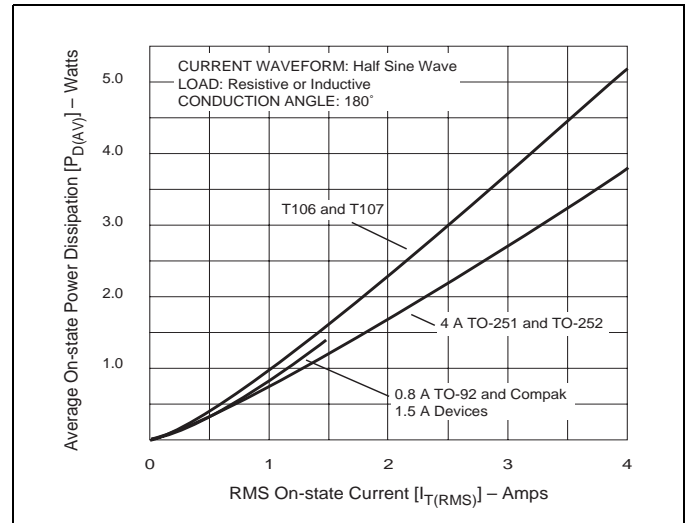

Figure E5.16 Power Dissipation (Typical) versus RMS On-state Current

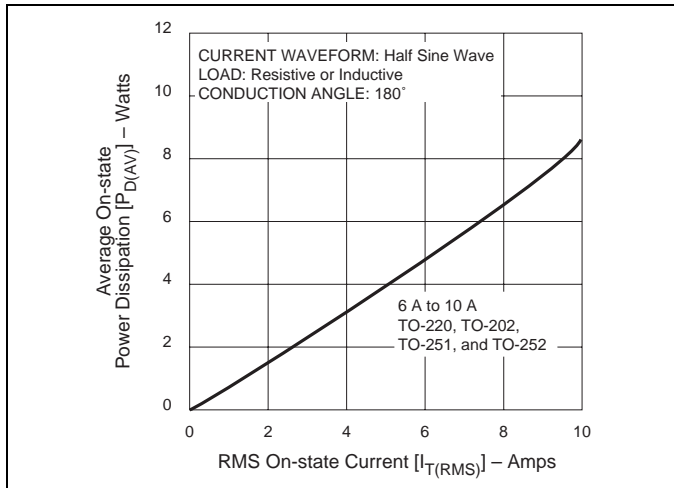

Figure E5.17 Power Dissipation (Typical) versus RMS On-state Current

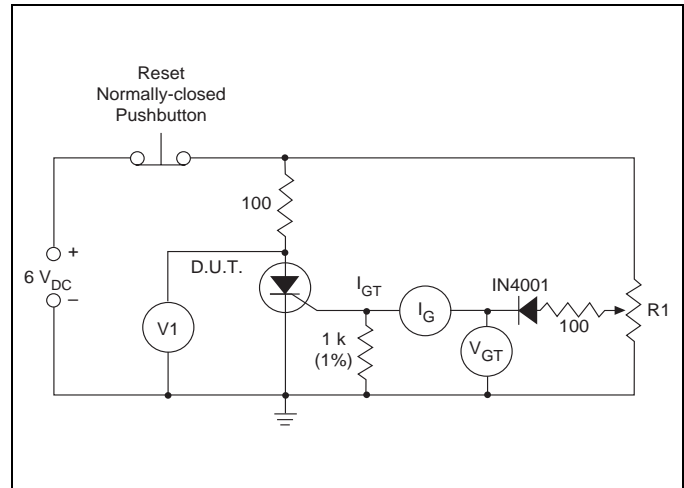

Figure E5.19 Simple Test Circuit for Gate Trigger Voltage and Current Measurement

Note: V1 — 0 V to 10 V dc meter
V_{GT} — 0 V to 1 V dc meter
I_G — 0 mA to 1 mA dc milliammeter
R1 — 1 k potentiometer

To measure gate trigger voltage and current, raise gate voltage (V_{GT}) until meter reading V1 drops from 6 V to 1 V. Gate trigger voltage is the reading on V_{GT} just prior to V1 dropping. Gate trigger current I_{GT} can be computed from the relationship

$$I_{GT} = I_G - \frac{V_{GT}}{1000} \text{ Amps}$$

where I_G is reading (in amperes) on meter just prior to V1 dropping.

Note: I_{GT} may turn out to be a negative quantity (trigger current flows out from gate lead). If negative current occurs, I_{GT} value is not a valid reading. Remove 1 k resistor and use I_G as the more correct I_{GT} value. This will occur on 12 μA gate products.

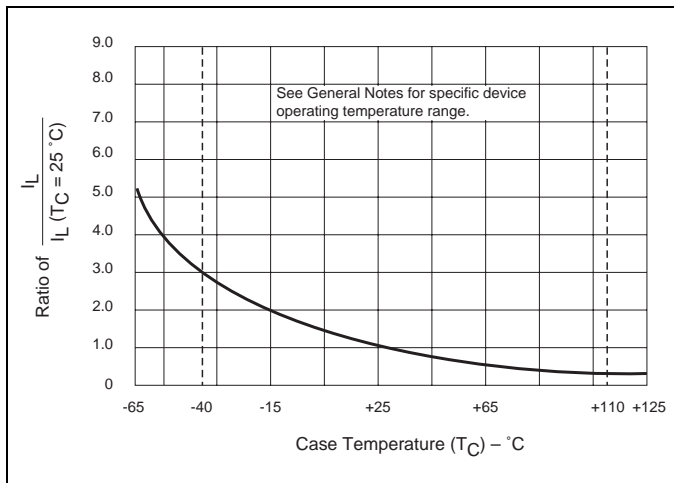

Figure E5.18 Normalized DC Latching Current versus Case Temperature

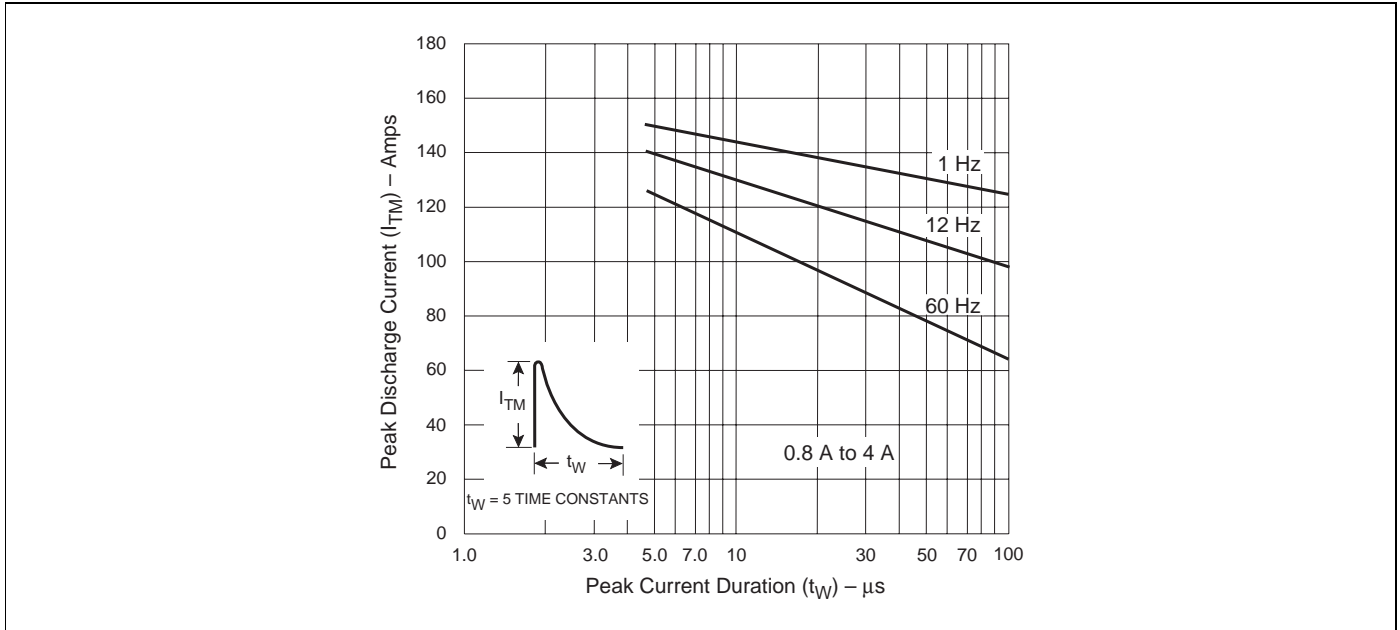

Figure E5.20 Peak Repetitive Capacitor Discharge Current

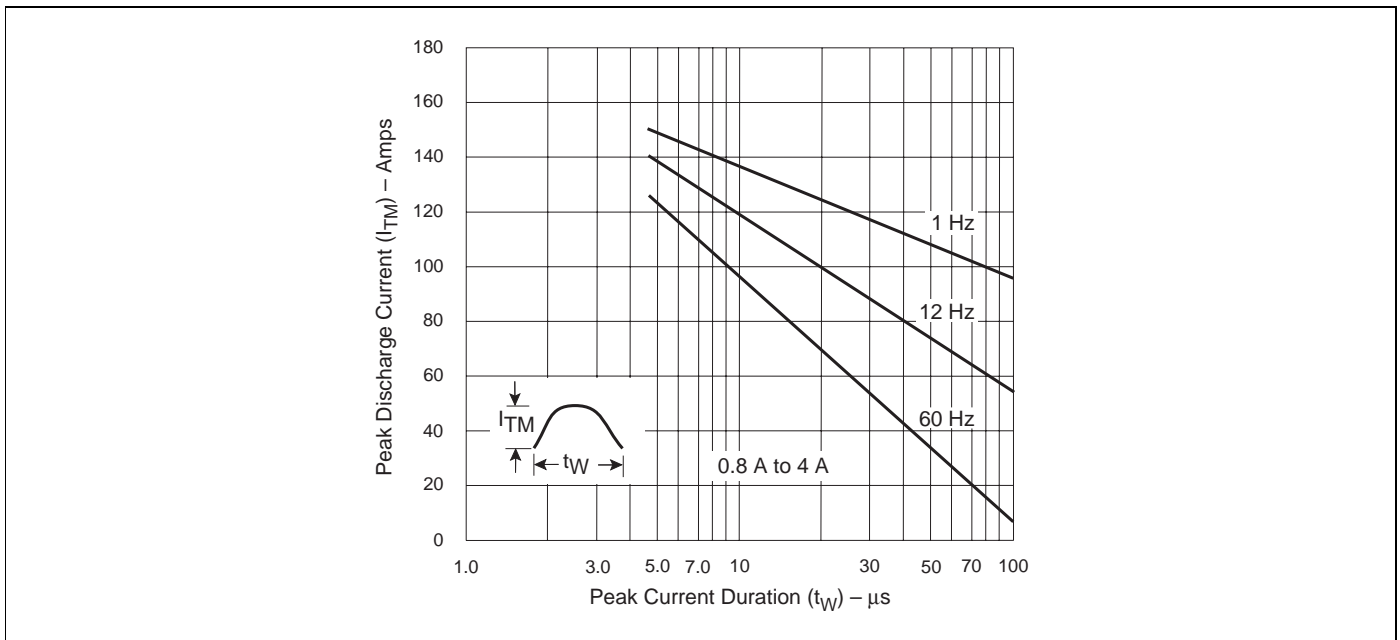

Figure E5.21 Peak Repetitive Sinusoidal Curve

